

Rheometry

SLIT RHEOMETER

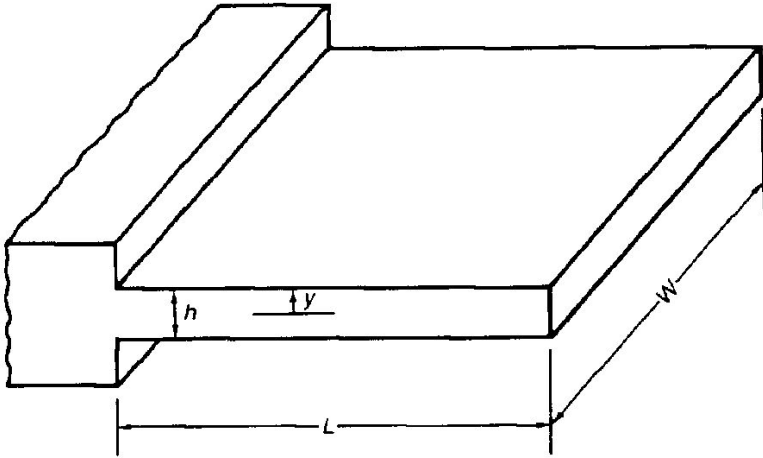

Figure 1: The Slit Rheometer. $L > W \gg h$.

$$\text{Shear Stress} \quad \sigma(y) = \frac{\Delta P}{L} y \quad (8-30)$$

$$\text{Wall Shear Stress} \quad \sigma_w = -\sigma(y = h/2) = \frac{-\Delta P h}{L} \frac{1}{2} \quad (8-31)$$

NEWTONIAN CASE

$$\text{Wall Shear Rate} \quad \dot{\gamma}_w = -\dot{\gamma}(y = h/2) = \frac{6Q}{h^2 w} \quad (8-32)$$

$$\text{Viscosity} \quad \eta = \frac{\sigma_w}{\dot{\gamma}_w} = \frac{-\Delta P}{L} \frac{h^3 w}{12Q} \quad (8-33)$$

Rheometry

SLIT RHEOMETER

NON-NEWTONIAN CASE

Correction for the real wall shear rate is analogous to the Rabinowitch correction.

$$\text{Wall Shear Rate} \quad \dot{\gamma}_w = \left(\frac{6Q}{h^2w} \right) \left(\frac{2 + \beta}{3} \right) \quad (8-34a)$$

$$\beta = \frac{d [\log(6Q/h^2w)]}{d [\log(\sigma_w)]} \quad (8-34b)$$

$$\text{Apparent Viscosity} \quad \eta = \frac{\sigma_w}{\dot{\gamma}_w} = \frac{-\Delta P}{L} \frac{h^3w}{4Q(2 + \beta)}$$

NORMAL STRESS DIFFERENCE

The normal stress difference N_1 can be determined from the exit pressure P_e .

$$N_1(\dot{\gamma}_w) = P_e + \sigma_w \left(\frac{dP_e}{d\sigma_w} \right) \quad (8-45)$$

$$N_1(\dot{\gamma}_w) = P_e \left(1 + \frac{d(\log P_e)}{d(\log \sigma_w)} \right) \quad (8-46)$$

These relations were calculated assuming straight parallel streamlines right up to the exit of the die. This assumption is not found to be valid in either experiment or computer simulation.

Rheometry

SLIT RHEOMETER NORMAL STRESS DIFFERENCE

$$N_1(\dot{\gamma}_w) = P_e + \sigma_w \left(\frac{dP_e}{d\sigma_w} \right) \quad (8-45)$$

$$N_1(\dot{\gamma}_w) = P_e \left(1 + \frac{d(\log P_e)}{d(\log \sigma_w)} \right) \quad (8-46)$$

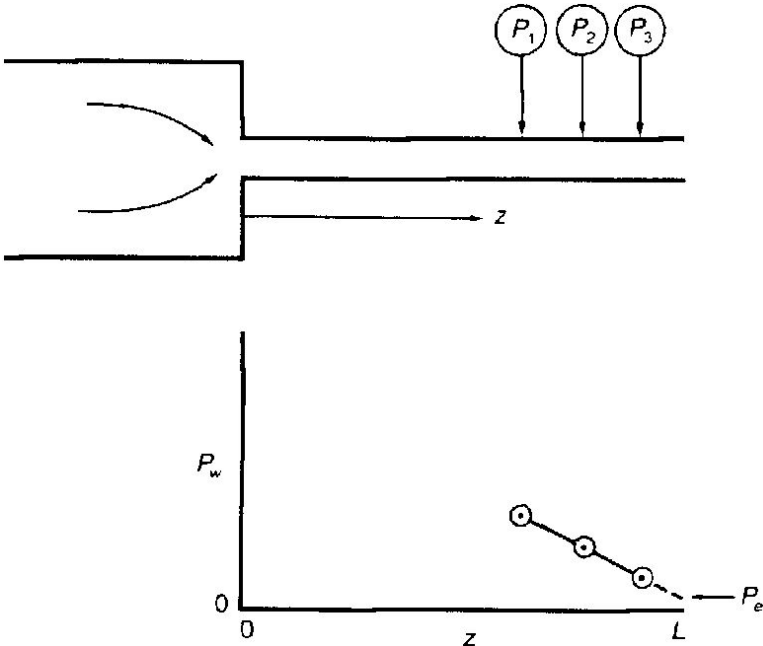

Figure 2: Determination of the Exit Pressure.

Rheometry

SLIT RHEOMETER

NORMAL STRESS DIFFERENCE

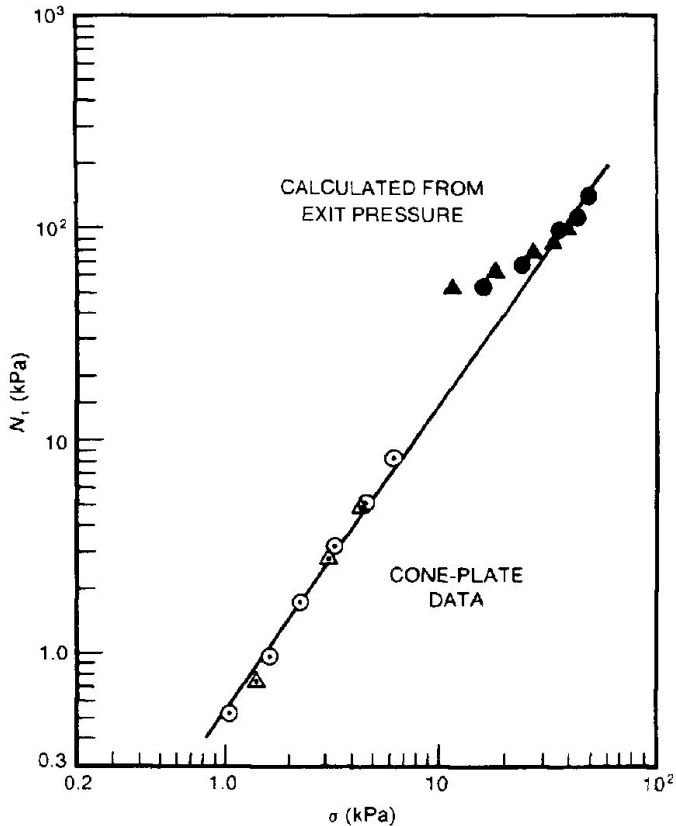

Figure 3: Comparison of First Normal Stress Difference Values for LDPE from Slit Rheometer Exit Pressure (filled symbols) and Cone&Plate (open symbols).

The poor agreement indicates that the more work is needed in order to use exit pressures to measure normal stress differences.

Rheometry

SLIT RHEOMETER

ENTRANCE PRESSURE DROP

There is a pressure drop in the flow contraction at the entrance of the slit die (just like the capillary die).

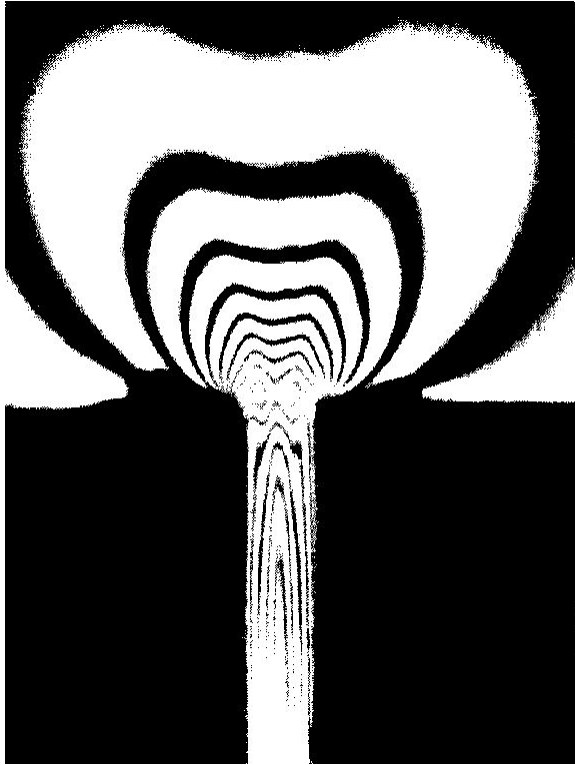

Figure 4: Birefringent Fringe Patterns for HDPE in the Entrance Region of a Slit Die.

However, using multiple flush-mounted pressure transducers avoids the necessity of the Bagley end correction in the slit rheometer.

Rheometry

SLIT AND CAPILLARY RHEOMETERS

DIE SWELL

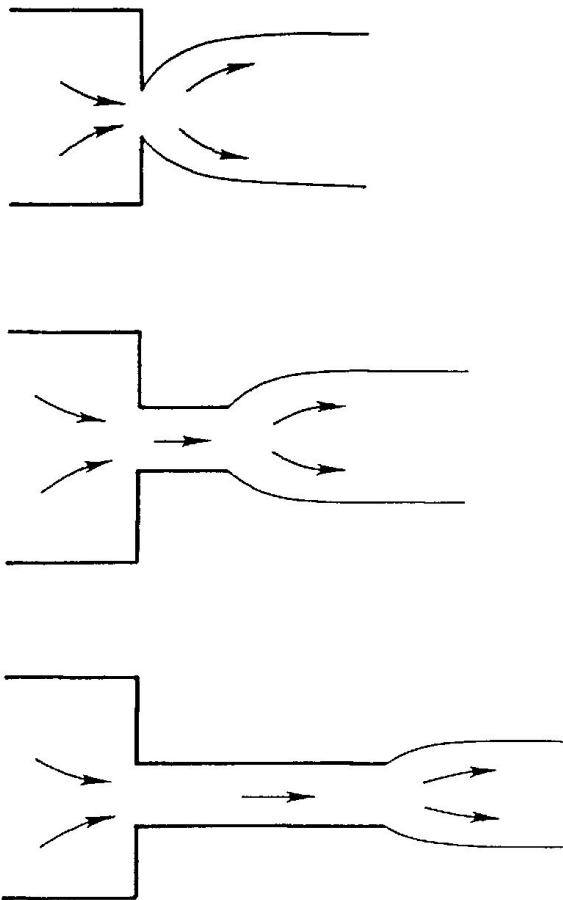

Figure 5: Extrudate Swell after Exiting the Die Diminishes as the Die is Made Longer.

Die swell is a viscoelastic memory effect from the flow contraction at the entrance to the die.

Rheometry

SLIT AND CAPILLARY RHEOMETERS

DIE SWELL

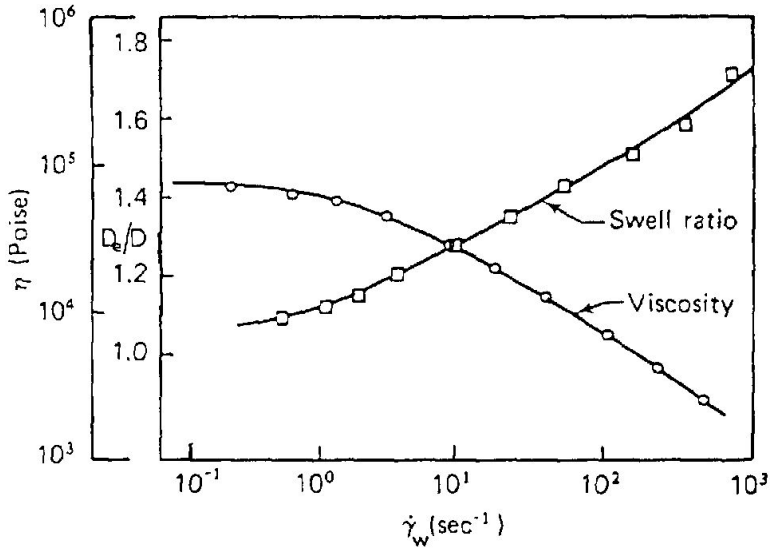

Figure 6: Apparent Viscosity and Die Swell Ratio for a Polystyrene in a Capillary Rheometer.

At $\dot{\gamma}_w = 10^{-1}\text{s}^{-1}$, the chain has time to relax during flow.

Deborah Number $\lambda\dot{\gamma}_w < 1$

λ is the molecular relaxation time.

$1/\dot{\gamma}_w$ is the experimental time scale.

At $\dot{\gamma}_w = 10^2\text{s}^{-1}$, the chain is stretched by the flow.

Deborah Number $\lambda\dot{\gamma}_w > 1$

Rheometry

SLIT AND CAPILLARY RHEOMETERS

DIE SWELL

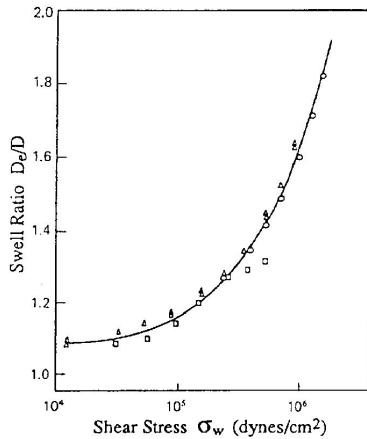
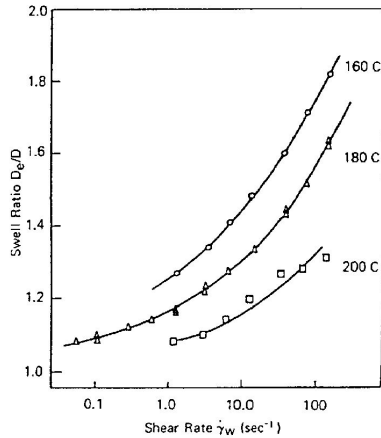

Figure 7: Die Swell Ratio from a Polystyrene in a Capillary Rheometer, as Functions of Wall Shear Rate and Wall Shear Stress.

For a given die, the die swell is a function of the wall shear **stress** in the liquid.

Rheometry

SLIT AND CAPILLARY RHEOMETERS

DIE SWELL

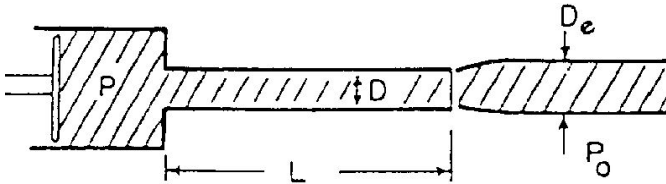

Figure 8: Capillary Die Swell.

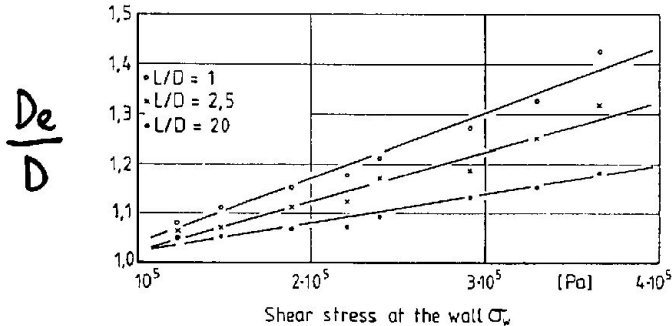

Figure 9: Die Swell from Three Different Capillary Dies.

Die swell is not a unique function of stress for different die geometries. Longer dies have less die swell (at the same shear stress) because the memory of the flow contraction at the entrance fades with increasing die length.

Rheometry

SLIT AND CAPILLARY RHEOMETERS

DIE SWELL

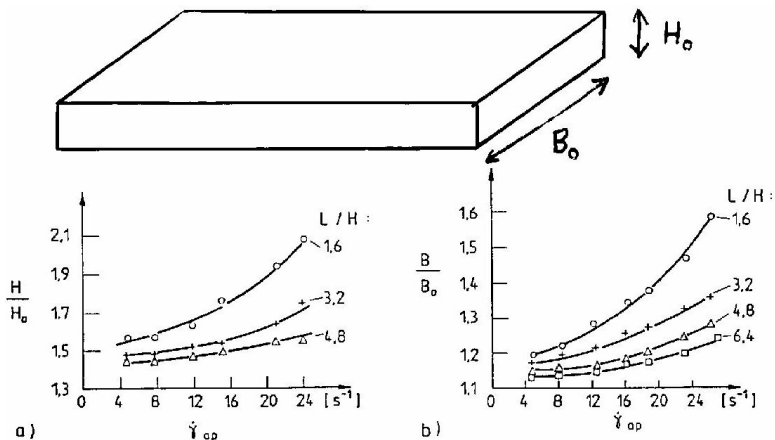

Figure 10: Die Swell in a Slit Die.

Die swell also has important consequences in polymer processing, as dies must be designed with extrudate swell in mind. Changing polymer also changes the amount of die swell.

Rheology is an important quality control tool to verify that raw materials are the same from batch to batch. Often viscosity and die swell from a capillary rheometer are checked for quality control.

Rheometry

SLIT AND CAPILLARY RHEOMETERS

EXTRUDATE DISTORTION

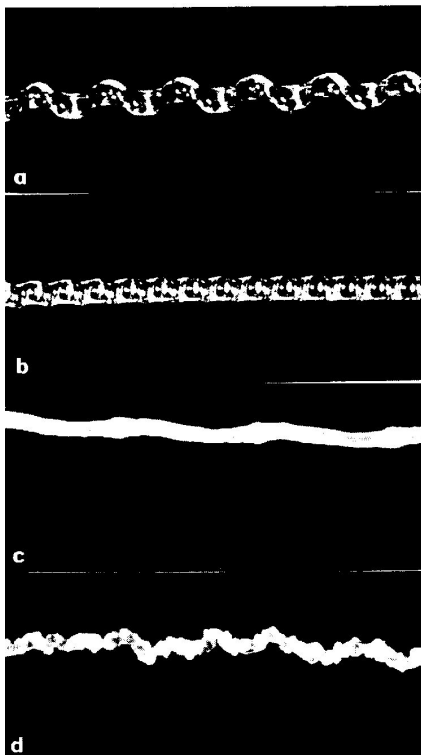

Figure 11: Examples of Extrudate Distortion: (a) Spiralling, (b) Oscillatory Ripple, (c) Bambooning, and (d) Random Melt Fracture. At high rates (and stresses) a variety of flow instabilities can occur.

Rheometry

SLIT AND CAPILLARY RHEOMETERS

EXTRUDATE DISTORTION

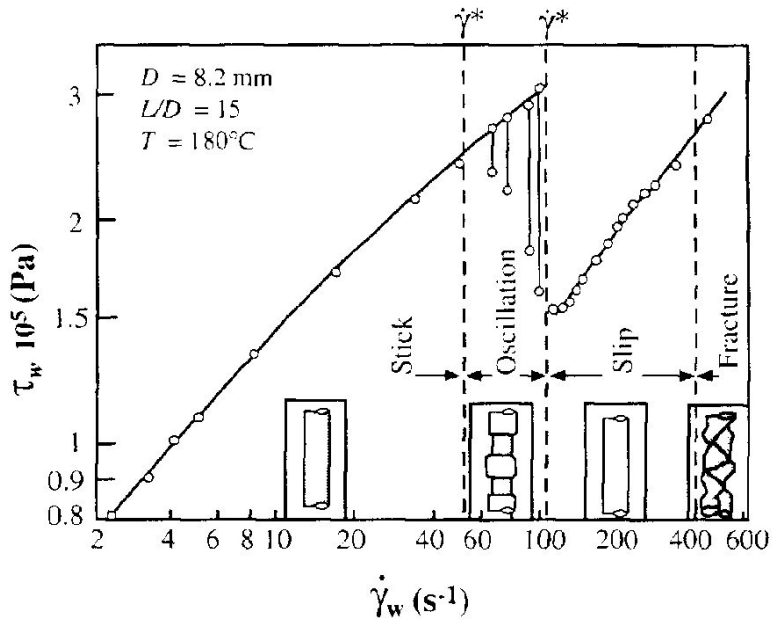

Figure 12: Wall Shear Stress vs. Wall Shear Rate for HDPE Showing Flow Instabilities and Wall Slip.

Rheometry

MELT FLOW INDEX “RHEOMETER”

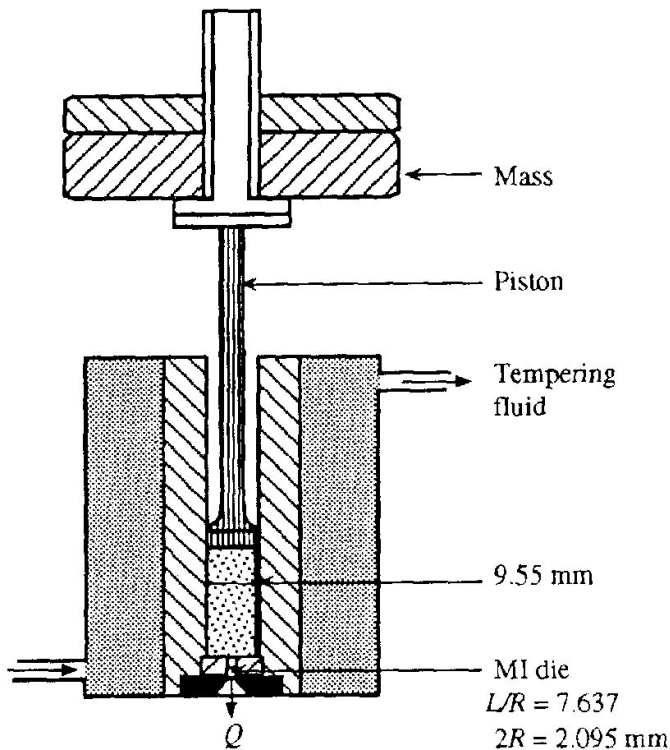
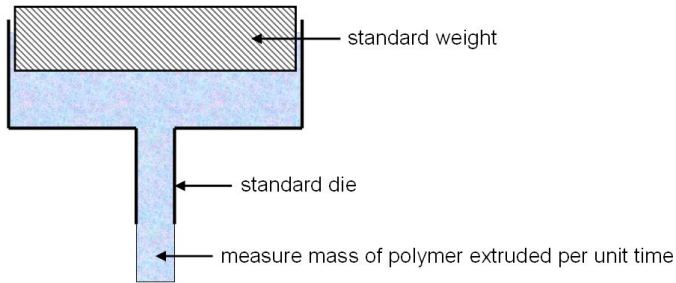

Figure 13: The Melt Flow Indexer.

Rheometry

MELT-FLOW INDEX



$$MFI = \rho Q \quad \text{at constant stress}$$

$$\text{If Newtonian, know } \mu = \frac{\pi \Delta P R^4}{8QL} \quad \mu \sim \frac{1}{MFI}$$

Polymers are non-Newtonian

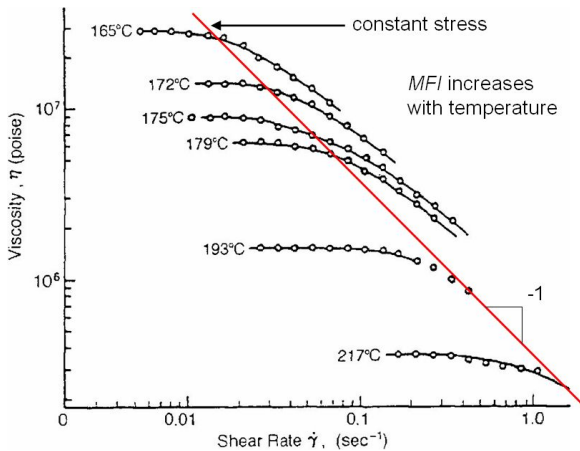

Figure 14: Viscosity versus shear rate for a nearly monodisperse polystyrene at several temperatures.

Rheometry

MELT-FLOW INDEX

Can a single point measurement characterize $\eta(\dot{\gamma})$?

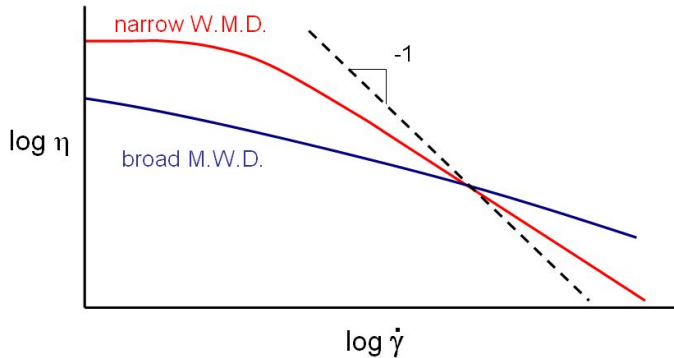

Figure 15: Viscosity versus shear rate for a nearly monodisperse polystyrene at several temperatures.

Two polymers have the same melt flow index, but *very* different flow properties.

MFI is only useful for quality control if the molecular weight distributions of the materials are all similar.

MFI is *useless* for process modeling.

MFI is the single most widely used quality control measure in the plastics industry.